

TOSHIBA Photocoupler GaAs Ired & Photo-Transistor

TLP626, TLP626-2, TLP626-4

Programmable Controllers
AC / DC-Input Module
Telecommunication

The TOSHIBA TLP626, -2 and -4 consist of gallium arsenide infrared emitting diodes connected in inverse parallel, optically coupled to a photo-transistor.

The TLP626-2 offers two isolated channels in an eight lead plastic DIP, while the TLP626-4 provides four isolated channels in a sixteen plastic DIP.

- Collector-emitter voltage: 55V(min.)
- Current transfer ratio

Classi- fication	Current Transfer Ratio(min.)			Marking Of Classi- fication
	Ta = 25°C		Ta = -25~75°C	
	If = ±1mA VCE = 0.5V	If = ±0.5mA VCE = 1.5V	If = ±1mA VCE = 0.5V	
Rank BV	200%	100%	100%	BV
Standard	100%	50%	50%	BV, blank

- Isolation voltage: 5000V_{rms} min.
- UL recognized: UL1577, file no.E67349
- BSI approved: BS EN60065: 1994 certificate no.7426
BS EN60950: 1992 certificate no.7427
- Note: Application type name for certification test,
please use standard product type name, i.e.
TLP626(BV): TLP626

Unit in mm

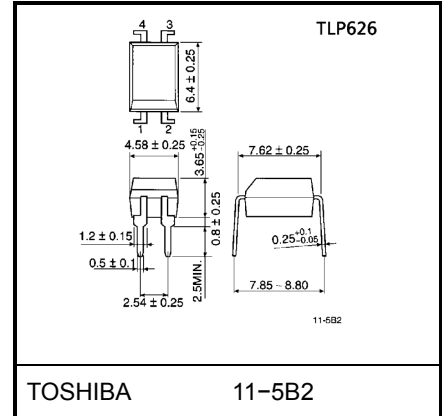

Weight: 0.26g

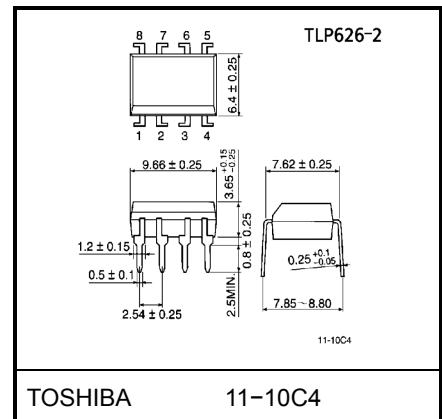

Weight: 0.54g

Pin Configuration (top view)

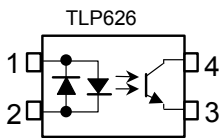

- 1 : Anode
- 2 : Cathode
- 3 : Emitter
- 4 : Collector

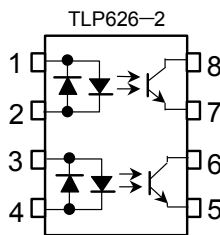

- 1, 3 : Anode
- 2, 4 : Cathode
- 5, 7 : Emitter
- 6, 8 : Collector

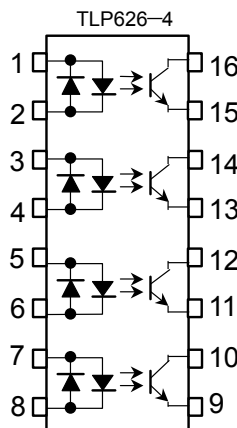

- 1, 3, 5, 7 : Anode, Cathode
- 2, 4, 6, 8 : Cathode, Anode
- 9, 11, 13, 15 : Emitter
- 10, 12, 14, 16 : Collector

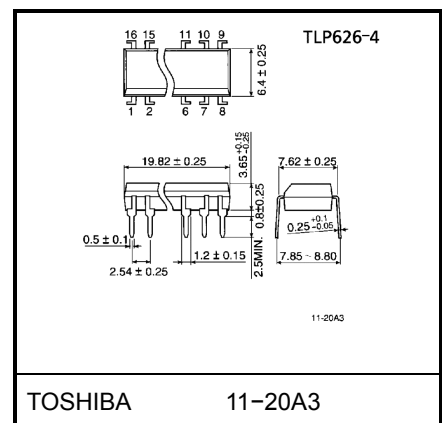

Weight: 1.1g

Maximum Ratings (Ta = 25°C)

Characteristic		Symbol	Rating		Unit
			TLP626	TLP626-2 TLP626-4	
LED	Forward current	I_F	60	50	mA
	Forward current derating	$\Delta I_F / ^\circ\text{C}$	-0.7(Ta ≥ 39°C)	-0.5(Ta ≥ 39°C)	mA / °C
	Pulse forward current	I_{FP}	1(100μs pulse, 100pps)		A
	Power dissipation (1 circuit)	P_D	100	70	mW
	Power dissipation derating (Ta ≥ 25°C, 1 circuit)	$\Delta P_D / ^\circ\text{C}$	-1.0	-0.7	mW / °C
	Junction temperature	T_j	125		°C
Detector	Collector-emitter voltage	V_{CEO}	55		V
	Emitter-collector voltage	V_{ECO}	7		V
	Collector current	I_C	50		mA
	Collector power dissipation (1 circuit)	P_C	150	100	mW
	Collector power dissipation derating (Ta ≥ 25°C, 1 circuit)	$\Delta P_C / ^\circ\text{C}$	-1.5	-1.0	mW / °C
	Junction temperature	T_j	125		°C
Storage temperature range		T_{stg}	-55~125		°C
Operating temperature range		P_{opr}	-55~100		°C
Lead soldering temperature		T_{sol}	260(10s)		°C
Total package power dissipation (1 circuit)		P_T	250	150	mW
Total package power dissipation derating (Ta ≥ 25°C, 1 circuit)		$\Delta P_T / ^\circ\text{C}$	-2.5	-1.5	mW / °C
Isolation voltage (Note 1)		BV_S	5000(AC, 1min., RH≤60%)		Vrms

(Note 1) Device considered a two terminal: LED side pins shorted together, and detector side pins shorted together.

Recommended Operating Conditions

Characteristic	Symbol	Min.	Typ.	Max.	Unit
Supply voltage	V_{CC}	—	5	24	V
Forward current	$I_{F(RMS)}$	—	1.6	20	mA
Collector current	I_C	—	1	10	mA
Operating temperature	T_{opr}	-25	—	75	°C

Individual Electrical Characteristics (Ta = 25°C)

Characteristic		Symbol	Test Condition	Min.	Typ.	Max.	Unit
LED	Forward voltage	V_F	$I_F = \pm 10\text{mA}$	1.0	1.15	1.3	V
	Reverse current	I_F	$V_F = \pm 0.7\text{V}$	—	2.5	20	μA
	Capacitance	C_T	$V = 0, f = 1\text{MHz}$	—	60	—	pF
Detector	Collector-emitter breakdown voltage	$V_{(BR)CEO}$	$I_C = 0.5\text{mA}$	55	—	—	V
	Emitter-collector breakdown voltage	$V_{(BR)ECO}$	$I_E = 0.1\text{mA}$	7	—	—	V
	Collector dark current	I_{CEO}	$V_{CE} = 24\text{V}$	—	10	10	nA
			$V_{CE} = 24\text{V}, T_a = 85^\circ\text{C}$	—	2	50	μA
Capacitance collector to emitter	C_{CE}	$V=0, f=1\text{MHz}$	—	12	—	pF	

Coupled Electrical Characteristics (Ta = 25°C)

Characteristic	Symbol	Test Condition	Min.	Typ.	Max.	Unit
Current transfer ratio	I_C / I_F	$I_F = \pm 1\text{mA}, V_{CE} = 0.5\text{V}$ rank BV	100	—	1200	%
			200	—	1200	
Low input CTR	$I_C / I_F(\text{low})$	$I_F = \pm 0.5\text{mA}, V_{CE} = 1.5\text{V}$ rank BV	50	—	—	%
			100	—	—	
Collector-emitter saturation voltage	$V_{CE(\text{sat})}$	$I_C = 0.5\text{mA}, I_F = \pm 1\text{mA}$ $I_C = 1\text{mA}, I_F = \pm 1\text{mA}$ rank BV	—	—	0.4	V
			—	0.2	—	
			—	—	0.4	
Off-state collector current	$I_{C(\text{off})}$	$V_F = \pm 0.7\text{V}, V_{CE} = 24\text{V}$	—	1	10	μA
CTR symmetry *1	$I_C(\text{ratio})$	$I_C(I_F = -1\text{mA}) / I_C(I_F = 1\text{mA})$	0.5	—	2	—

Coupled Electrical Characteristics (Ta = -25~75°C)

Characteristic	Symbol	Test Condition	Min.	Typ.	Max.	Unit
Current transfer ratio	I_C / I_F	$I_F = 1\text{mA}, V_{CE} = 0.5\text{V}$ rank BV	50	—	—	%
			100	—	—	
Low input CTR	$I_C / I_F(\text{low})$	$I_F = 0.5\text{mA}, V_{CE} = 1.5\text{V}$ rank BV	—	50	—	%
			—	100	—	

*1

$$I_C(\text{ratio}) = \frac{I_{C2}(I_F = I_{F2}, V_{CE} = 5\text{V})}{I_{C1}(I_F = I_{F1}, V_{CE} = 5\text{V})}$$

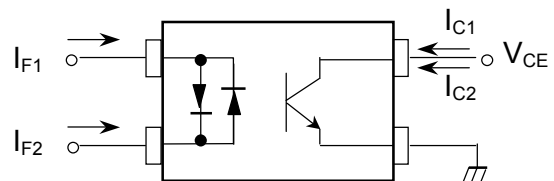

Isolation Characteristics (Ta = 25°C)

Characteristic	Symbol	Test Condition	Min.	Typ.	Max.	Unit
Capacitance input to output	C _S	V _S = 0, f = 1MHz	—	0.8	—	pF
Isolation resistance	R _S	V _S = 500V	5×10 ¹⁰	10 ¹⁴	—	Ω
Isolation voltage	BV _S	AC, 1 minute	5000	—	—	Vrms
		AC, 1 second, in oil	—	10000	—	Vrms
		DC, 1 minute, in oil	—	10000	—	Vdc

Switching Characteristics (Ta = 25°C)

Characteristic	Symbol	Test Condition	Min.	Typ.	Max.	Unit
Rise time	t _r	V _{CC} = 10V, I _C = 2mA R _L = 100Ω	—	8	—	μs
Fall time	t _f		—	8	—	
Turn-on time	t _{on}		—	10	—	
Turn-off time	t _{off}		—	8	—	
Turn-on time	t _{ON}	R _L = 4.7kΩ (Fig.1) V _{CC} = 5V, I _F = ±1.6mA	—	10	—	μs
Storage time	t _s		—	50	—	
Turn-off time	T _{OFF}		—	300	—	

Fig. 1 Switching operating conditions

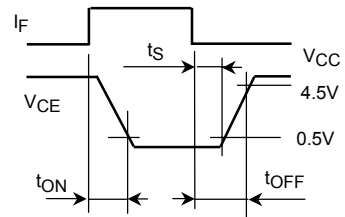
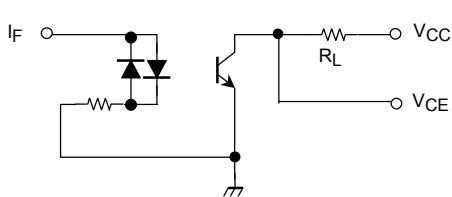

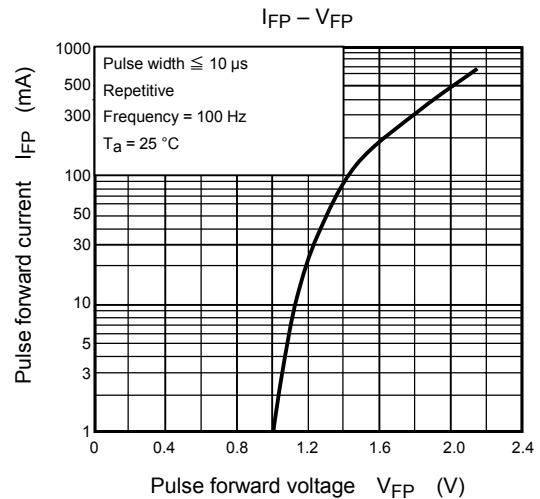
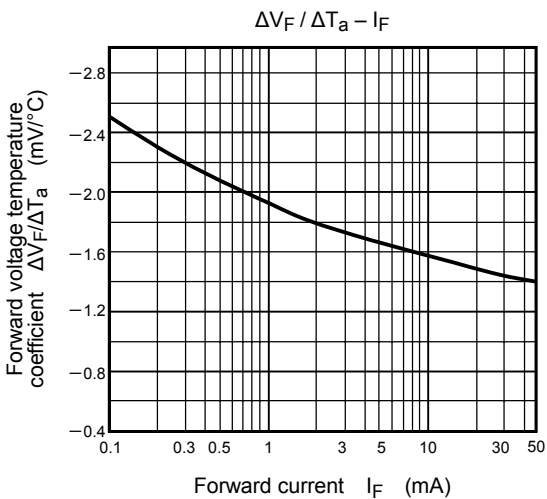
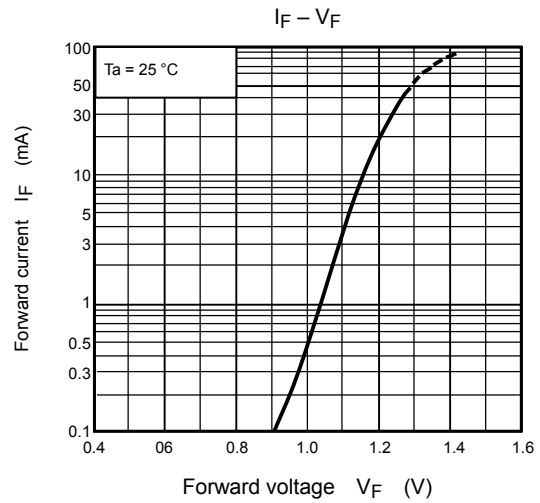
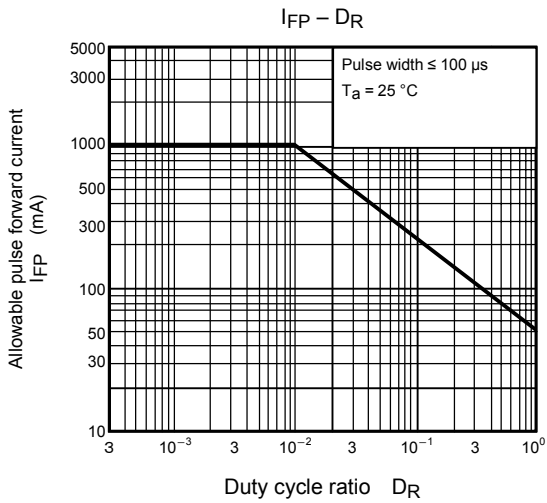
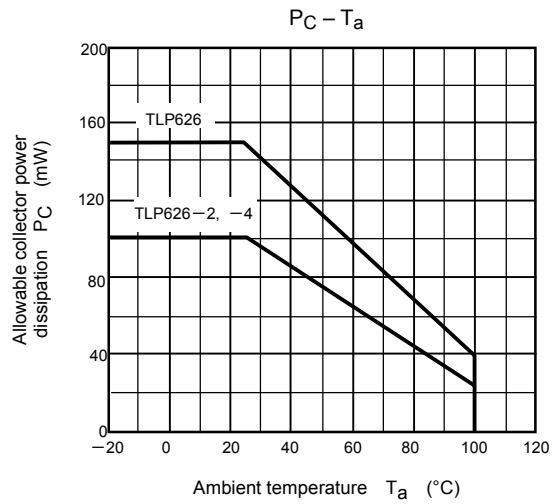
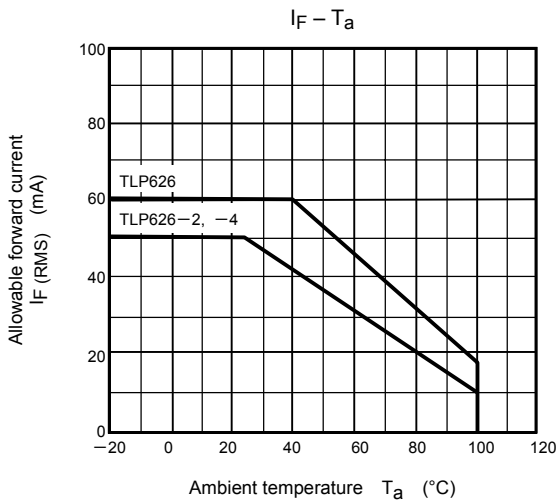

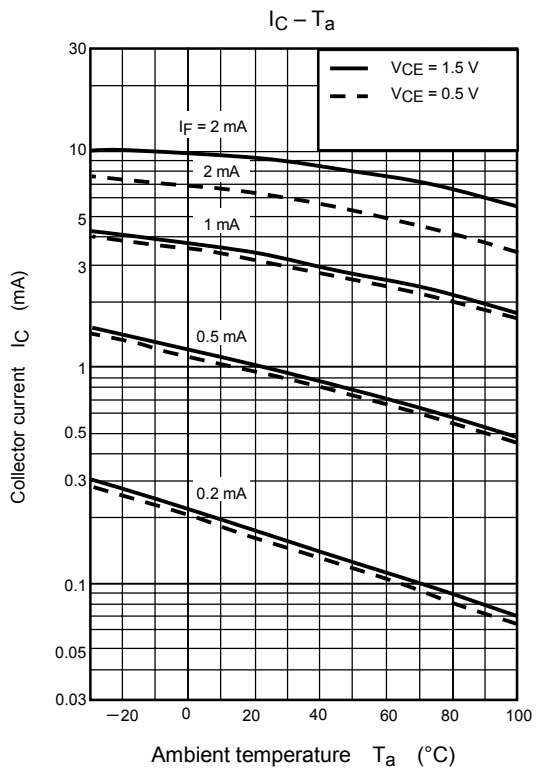
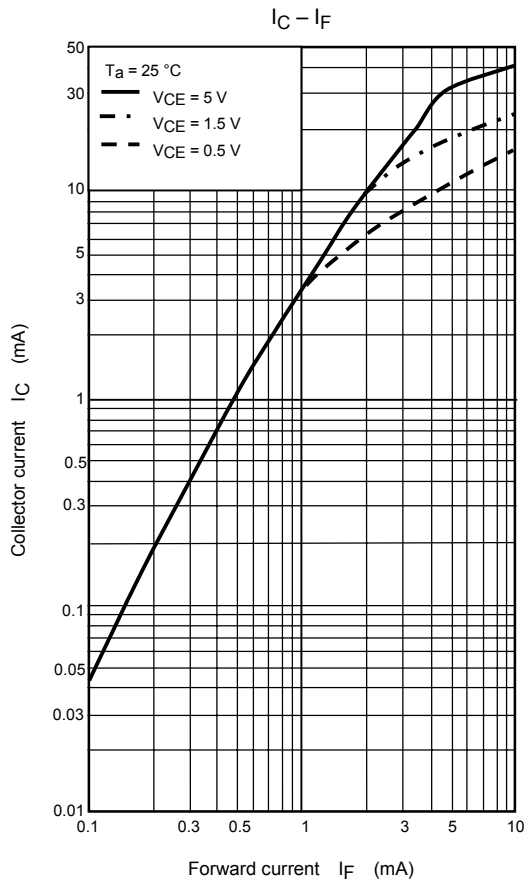
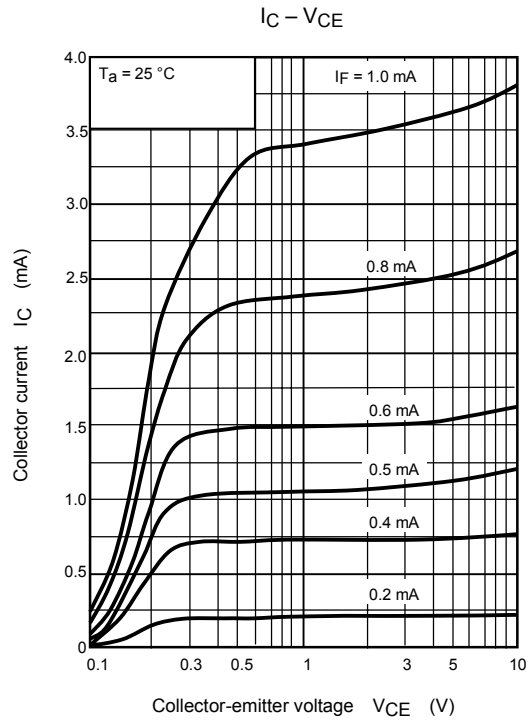
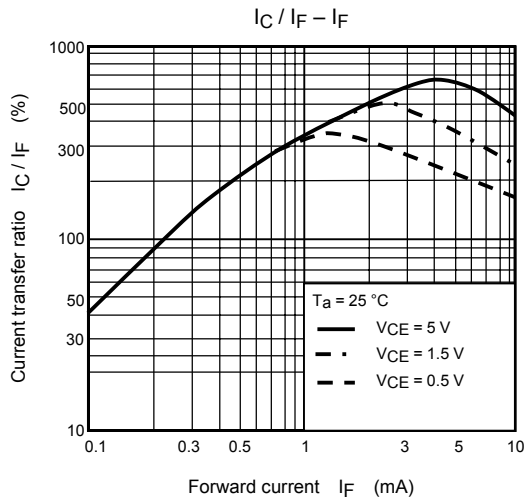

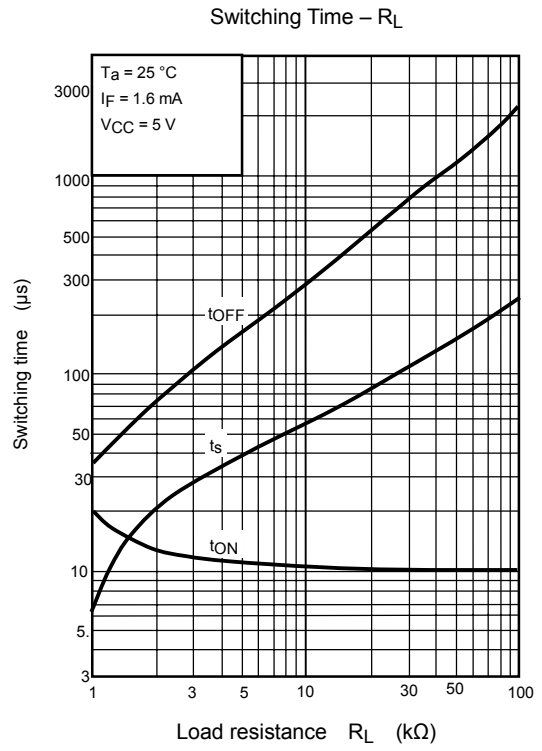
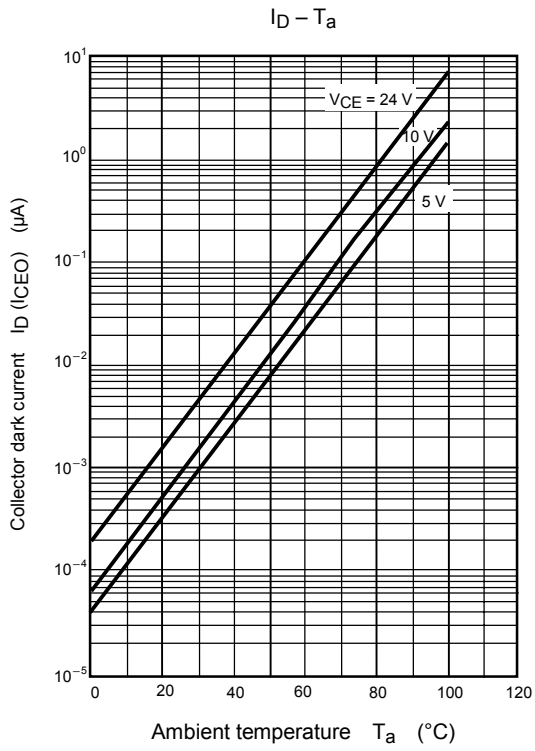

RESTRICTIONS ON PRODUCT USE

000707EBC

- TOSHIBA is continually working to improve the quality and reliability of its products. Nevertheless, semiconductor devices in general can malfunction or fail due to their inherent electrical sensitivity and vulnerability to physical stress. It is the responsibility of the buyer, when utilizing TOSHIBA products, to comply with the standards of safety in making a safe design for the entire system, and to avoid situations in which a malfunction or failure of such TOSHIBA products could cause loss of human life, bodily injury or damage to property.
In developing your designs, please ensure that TOSHIBA products are used within specified operating ranges as set forth in the most recent TOSHIBA products specifications. Also, please keep in mind the precautions and conditions set forth in the "Handling Guide for Semiconductor Devices," or "TOSHIBA Semiconductor Reliability Handbook" etc..
- The TOSHIBA products listed in this document are intended for usage in general electronics applications (computer, personal equipment, office equipment, measuring equipment, industrial robotics, domestic appliances, etc.). These TOSHIBA products are neither intended nor warranted for usage in equipment that requires extraordinarily high quality and/or reliability or a malfunction or failure of which may cause loss of human life or bodily injury ("Unintended Usage"). Unintended Usage include atomic energy control instruments, airplane or spaceship instruments, transportation instruments, traffic signal instruments, combustion control instruments, medical instruments, all types of safety devices, etc.. Unintended Usage of TOSHIBA products listed in this document shall be made at the customer's own risk.
- Gallium arsenide (GaAs) is a substance used in the products described in this document. GaAs dust and fumes are toxic. Do not break, cut or pulverize the product, or use chemicals to dissolve them. When disposing of the products, follow the appropriate regulations. Do not dispose of the products with other industrial waste or with domestic garbage.
- The products described in this document are subject to the foreign exchange and foreign trade laws.
- The information contained herein is presented only as a guide for the applications of our products. No responsibility is assumed by TOSHIBA CORPORATION for any infringements of intellectual property or other rights of the third parties which may result from its use. No license is granted by implication or otherwise under any intellectual property or other rights of TOSHIBA CORPORATION or others.
- The information contained herein is subject to change without notice.